



HE * A USER GUIDE



www.vincross.com

© 2017 Vincross Inc. All rights reserved.

Hello,

I'm Tianqi, the creator of HEXA. I am so happy that you have chosen to open the user guide and read my letter. I expected about 73% of the Human Mentors would skip the guide and immediately start playing with HEXA. I get it! However, I hope you will all refer to the user guide in case of any questions.

Normally in an opening letter, I would talk to you all about a bright future with endless possibilities. But that is meaningless at this point. For you already have embarked on this journey. You already have a HEXA in hand and I know for sure, you already have a very strong idea about the future and that's why you are here.

I am very happy that we are the first group of Human Mentors about to enter into the world of robot development. It is my hope that 30 years from now, we will all be speaking the same truth. Something along the lines of...

"One day I opened a box. At that very moment, I became the first group of Human Mentors tasked with bringing robots to life."

Have fun with HEXA!

Cheers,
Tianqi Sun

A handwritten signature in black ink, appearing to read 'Tianqi Sun', with a long, sweeping underline.

Table of Contents

Part 1: Getting Started

Say hi to HEXA	02
Introducing HEXA	02
HEXA	03
HEXA posterior	04
Hardware interfaces	05
Activate HEXA	06
Download the HEXA App to activate HEXA	06
Activate additional HEXAs	12
Troubleshooting for unsuccessful HEXA activation	15
Connect to HEXA with your mobile device	16
Using Wi-Fi mode to connect HEXA	16
Troubleshooting for Wi-Fi mode connection	20
Use Direct Link mode to connect to HEXA	24
Troubleshooting for Direct Link mode connection	27
Reset HEXA	28
How to reset HEXA	28
Skill	30
HEXA pre-installed Skills	30
Use Skills in Launcher	31
Play around with pre-installed Skills	31
Download more Skills	39
Transferring HEXA ownership	40
How to transfer HEXA ownership	40

Part 2: Open Platform & Developer Tools

HEXA is an open platform for robot developers	42
MIND SDK	42
Developer Bridge	42
Developer Forum	43

Part 3: HEXA's Features and Parameters

Power light	45
Head light	46
Visual system	47
Explore, take pictures and videos	48
Power and charge	49
Battery display	49
Charging	50
Legs	51
Specs	52

Part 4: Services and System Updates

Services and support	57
System update	58
Update "HEXA User Guide"	59

Part 1
Getting Started

Say hi to HEXA

Introducing HEXA

HEXA is an all-terrain hexapod robot designed and developed by Vincross Inc. It comes equipped with basic motion capacities such as walking, climbing, and passing through caves. It is also equipped with multiform interfaces such as a built-in camera, infrared transmitter, and a distance measuring sensor. Furthermore, HEXA is running MIND, a Linux-based OS, which allows developers to easily program their robot. Various hardware ports are available including USB, audio input and output, I²C, ADC, GPIO, and 5V/3.3V power output.

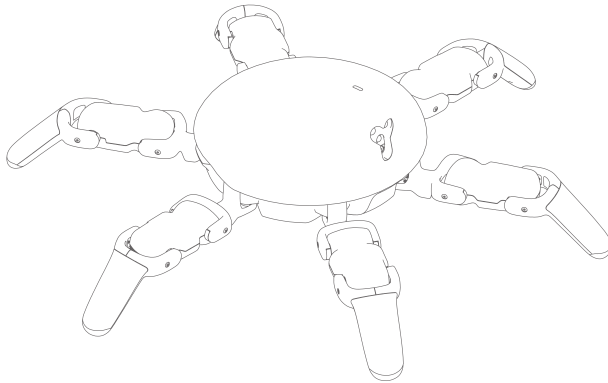

HEXA

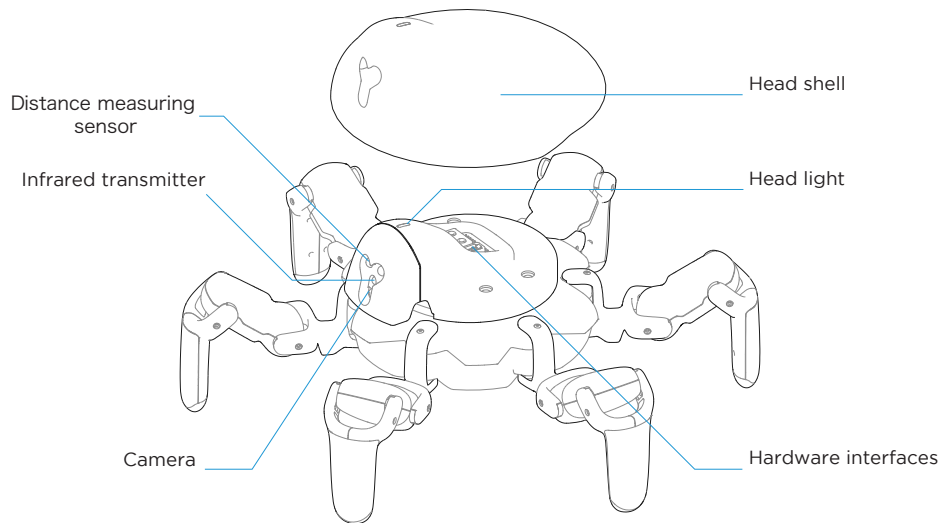

HEXA × 1

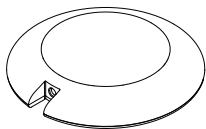

Wireless charging dock × 1

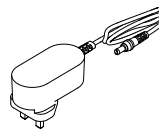

AC/DC adapter × 1

HEXA posterior

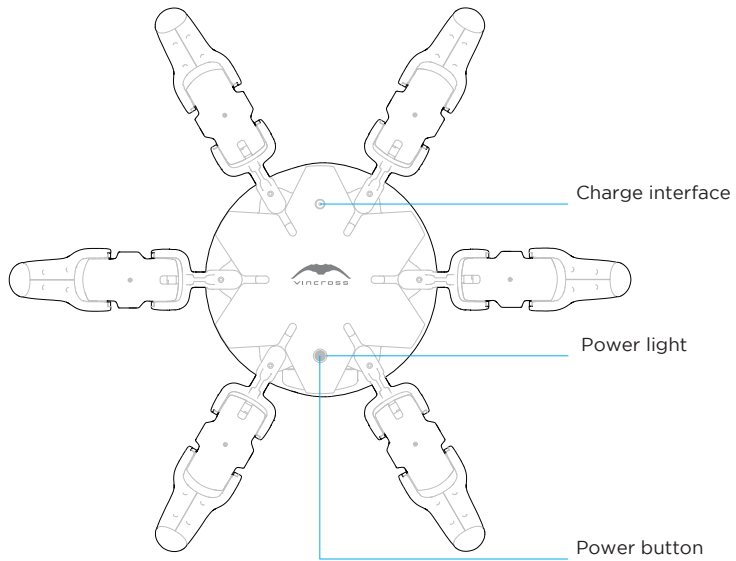

Hardware interfaces

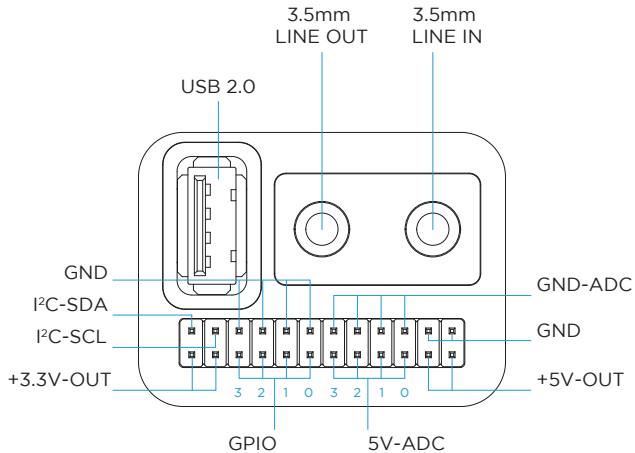

The hardware interfaces are located under the head shell.
(Pull up from the back of the head to remove shell.)

- ⊖ Use only the original **AC/DC adapter** in order to prevent serious damage to HEXA and/or fire.

Activate HEXA

Download the HEXA App to activate HEXA

In order to activate your HEXA, you must first download the HEXA App. You will then be guided through setup/register. The activation requires a Wi-Fi network with internet connection for your HEXA and mobile device.

Instructions for activating HEXA

1. Download HEXA App.

Upon downloading, you will be guided through setup and on-boarding. You must have a Wi-Fi network to provide an internet connection for both your HEXA and mobile device during initial setup.

For iOS users: Search "**Vincross HEXA**" in the App Store and download.

For Android users: Search "**Vincross HEXA**" on Google Play or directly download the App APK at <https://www.vincross.com/download-hexa-app>

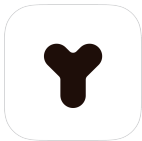



2. Open HEXA App while your mobile device is connected to a Wi-Fi network, and press **"Let's get started!"**

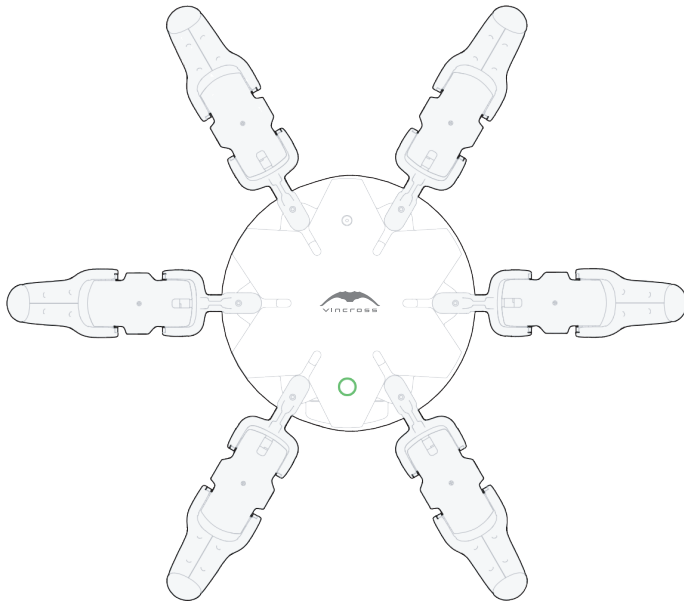

- 3.** Turn on HEXA's power button located on its posterior side. The power light will turn a steady green to indicate it is on.

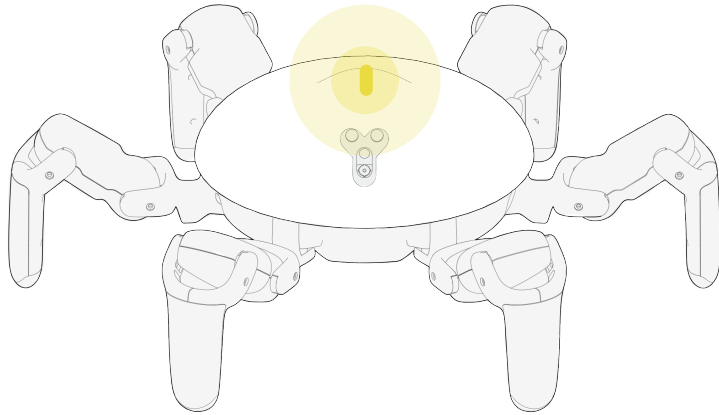

- 4.** The head light on the top side will show light purple for about 10 seconds. Then it will start blinking yellow.

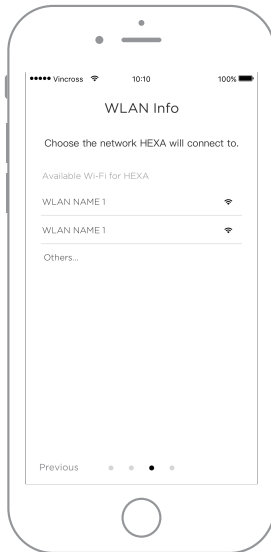

5. Choose a Wi-Fi network for HEXA and enter the password.

! HEXA is NOT able to connect to any of the wireless network that is: 5 GHz, enterprise secured, ad-hoc/peer-to-peer, or public networks that require a web browser for authentication.

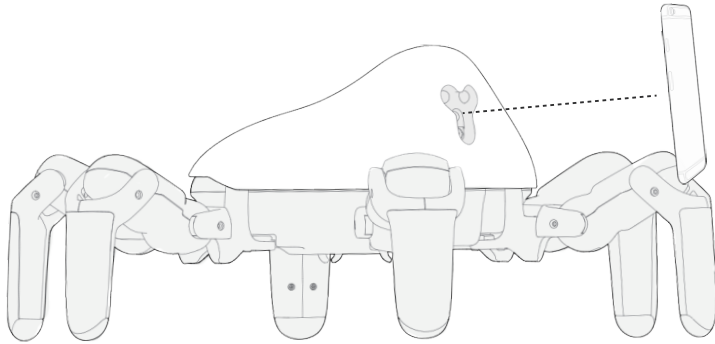

6. Place the QR code in front of HEXA's camera until the head light turns blue and stops blinking. Try to move slightly for focus. After wait about 30-60 seconds, the HEXA App will automatically connect the HEXA once activation complete. (Please goto Page 31 to see how to use Skills in Launcher.)

Activate additional HEXAs

The more HEXAs, the merrier. Follow these instructions for activating additional robots.

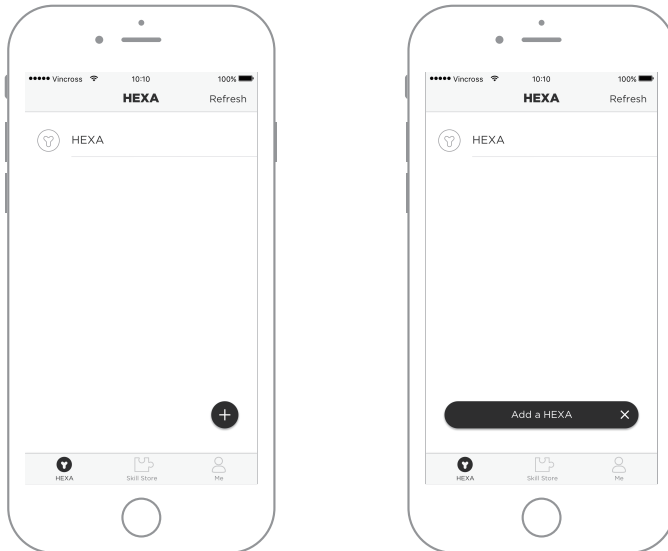

1. Open HEXA App and login to your Vincross account. Press the "+" button and then press **"Add a HEXA"** .

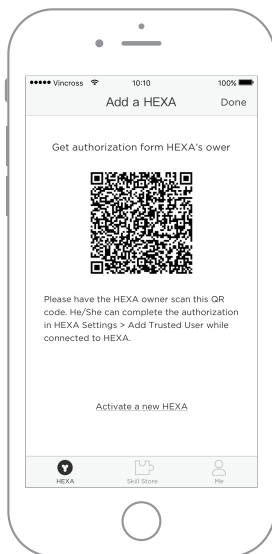

2. Press **"Activate a new HEXA"**.

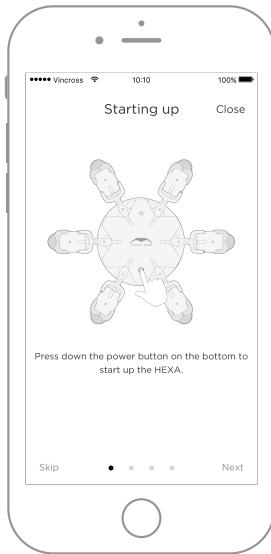

3. Finish the activation process by following the activation instructions shown on Page 6.

Troubleshooting for HEXA activation

If you are having problems connecting or activating HEXA, please consider the following:

Possible reasons	Solutions
HEXA failed to scan QR code.	Place the screen of your mobile phone with a vertical angle to the camera of HEXA, then adjust the distance between your phone and the camera.
Connection time out.	Move to a location with a better Wi-Fi signal.
You have entered an incorrect password.	Return to Step 2 and connect to Wi-Fi again. Make sure you are entering the correct password.
The Wi-Fi you joined doesn't have access to the internet.	Join another Wi-Fi, which is able to connect to the internet.
HEXA has been activated before.	The head light of HEXA blinks yellow about one minute then turns steady purple. Please contact the owner and get authorization if you want to connect.



If the problem persists, please contact support@vincross.com.



HEXA is NOT able to connect to any of the wireless network that is: 5 GHz, enterprise secured, ad-hoc/peer-to-peer, or public networks that require a web browser for authentication.



Connect to HEXA with your mobile device

There are two ways to connect HEXA to your mobile device.

1.   Wi-Fi mode (connect through the internet or LAN)
2.  Direct Link mode

Using Wi-Fi mode to connect HEXA

When your mobile device is connecting to HEXA using Wi-Fi, HEXA will automatically determine whether the current network environment is LAN or internet.

1. When HEXA and your mobile device are connected to the same Wi-Fi network, HEXA will appear as a  LAN connection.
2. When HEXA and your mobile device are connected to different Wi-Fi networks, HEXA will appear as an  internet connection.

How to connect to HEXA using Wi-Fi mode

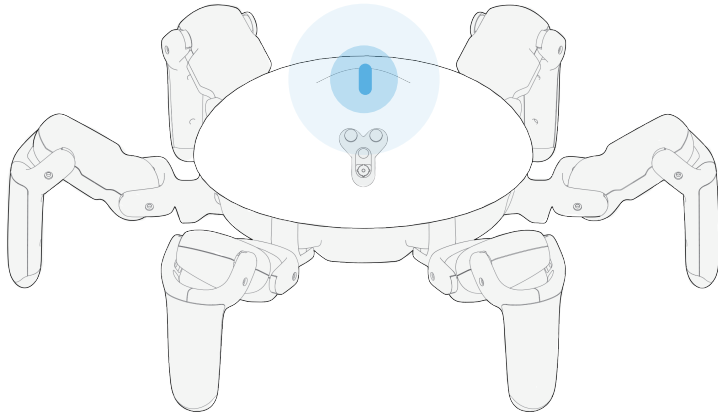

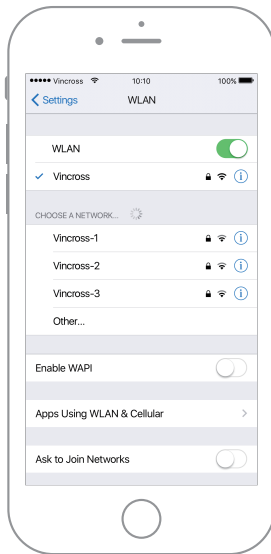

1. Turn on HEXA's power button. Its head light will **blink blue**, which shows it is connecting to Wi-Fi.

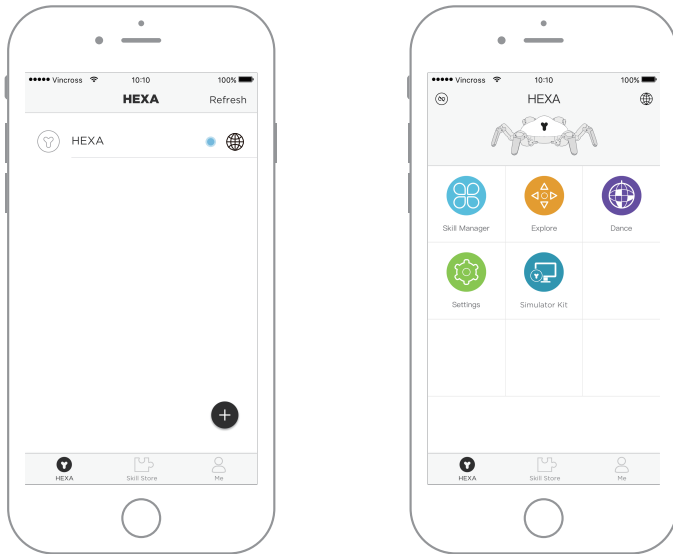

2. Connect mobile device to Wi-Fi network with internet access, and then open the HEXA App.



3. Refresh the HEXA list, you will see your HEXA with an  LAN connection icon or  Internet connection icon. Press the HEXA's name, then the HEXA App will connect to this HEXA and display the Launcher.

Troubleshooting for Wi-Fi mode connection

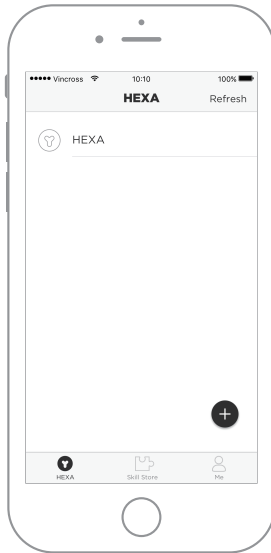

1. If you see your HEXA in the list with no icon, it means the HEXA App has not found your HEXA via Internet. In this case, you'll want to try alternative modes of connection, either adding a Wi-Fi for HEXA or switching to the Direct Link mode.

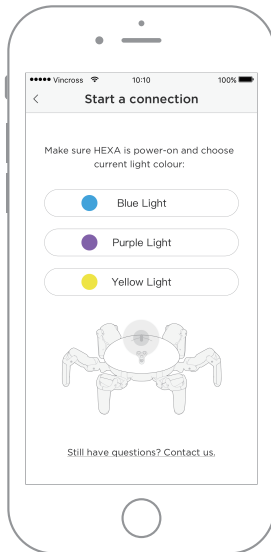

2. Press the HEXA's name and an instruction page will show up. Follow the instructions, for the following two cases.

Case 1: The color of HEXA's head light is yellow.

In this case, HEXA is waiting to scan QR code for Wi-Fi information, and HEXA is also able to be connected in Direct Link mode. If you choose to add a Wi-Fi for HEXA, press the "Yellow Light" button, then you will choose a network and get a QR code for HEXA. If you choose to use Direct Link mode, follow instruction on page 24.

Case 2: The color of HEXA's head light is purple.

In this case, HEXA has exceeded the waiting time limit and its camera has stopped receiving QR code. The purple light means it is in Direct Link mode. Please restart HEXA and follow the prompts to add a Wi-Fi for HEXA again. Or refer to "Use Direct Link mode to connect to the HEXA" on Page 24.

 HEXA is NOT able to connect to any of the following wireless options: 5 GHz, enterprise secured, ad-hoc/peer-to-peer, or public networks that require a web browser for authentication.

If you are having trouble with the Wi-Fi connection, please consider the following:

1. Make sure the Wi-Fi password inputted for HEXA is correct.
2. Reconfirm the Wi-Fi signal around HEXA is strong and steady.
3. Make sure you are the owner or a trusted user of this HEXA.

If the problem persists, please contact support@vincross.com.

Use Direct Link mode to connect to HEXA

Direct Link mode is designed for outdoor use or for environments where no Wi-Fi network exists. Under Direct Link mode, HEXA becomes a Wi-Fi hotspot. Once your mobile device connects to this hotspot, it can connect to HEXA through the HEXA App.

How to connect to HEXA using Direct Link mode



1. When you turn on HEXA and there is no available Wi-Fi network, the head light will shortly appear light purple before it blinks yellow, and it will finally stay in steady purple light. You are able to connect with HEXA using Direct Link mode when the head light is yellow or purple.



NOTE: Even when HEXA is connected to Wi-Fi, you can switch to Direct Link mode by visiting "Settings" in the HEXA App.

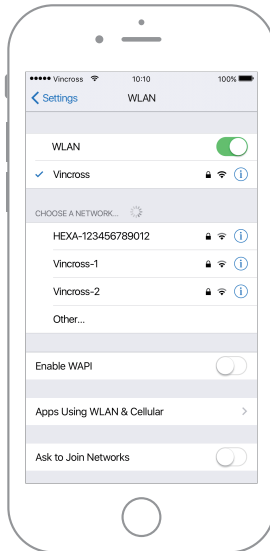

2. Open your mobile device's network settings. Among the available networks, select the network that is named HEXA-followed by a 12-digit number combination. Press "Connect" and enter the password which is the last 8 digits of the network name.

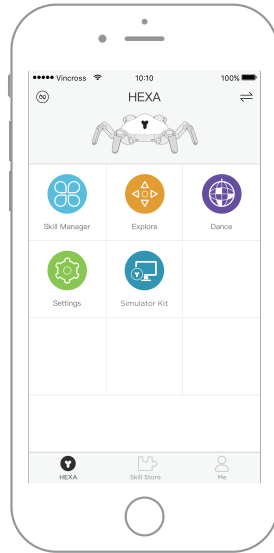
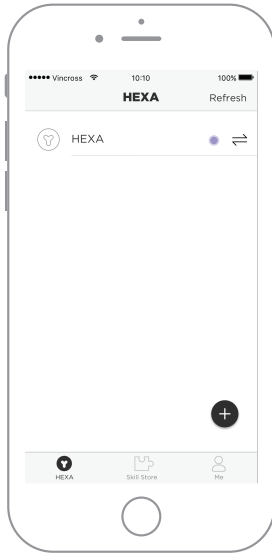

- 3.** Open HEXA App. The icon  indicates HEXA is under Direct Link mode. Click the HEXA's name and connect to it. You will then be able to enter HEXA Launcher.

Troubleshooting for Direct Link mode connection

If you are having troubles connecting to Direct Link mode, please consider the following:

- 1.** HEXA must be activated. Otherwise, it cannot enter Direct Link mode.
- 2.** If HEXA's head light turns blue, it means it is already auto-connected to a Wi-Fi network. Under this situation, HEXA cannot automatically enter Direct Link mode. You will need to manually switch to Direct Link mode in HEXA App "Settings".
- 3.** Please check the network settings of your mobile device. Make sure it is connected to HEXA's network.
- 4.** Please confirm that you are the owner or trusted user of this HEXA.
- 5.** Make sure that the distance between the mobile device and HEXA is within 160 feet (50 meters). Direct Link mode won't work beyond this distance.

If the problem persists, please contact support@vincross.com.

Reset HEXA

! Resetting HEXA will erase all user data and settings on your HEXA and the action is irreversible.

How to reset HEXA

1. First, make sure HEXA is powered off and is not connected to the charging cable, then plug in the Dupont wires as shown below.

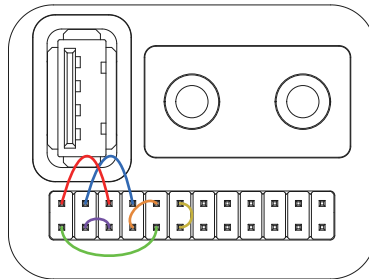

! Please make sure that HEXA is powered off and not connected with the charging cable while plugging in and plugging out the Dupont wires. Improper operation may cause damage to HEXA.

2. Turn on HEXA. It will reset itself automatically. The head light on HEXA will be steady purple for 5-10 seconds before it is ready to reset.
3. The head light on HEXA will be steady green when resetting. The process may take about 20 seconds.
4. When finished resetting, the head light on HEXA will blink yellow. At this point, please press HEXA's power button and turn it off.
5. Unplug the Dupont wires while HEXA is off.
6. Turn on HEXA again and activate it by following the activation instructions shown on Page 6.

Skill

A “Skill” is an application of HEXA. It is the equivalent to a software of an app on a mobile device.

HEXA Pre-installed Skills

We pre-install three skills for every HEXA: Explore, Dance and Simulator Kit. You will find them in the HEXA Launcher.

Explore enables HEXA to remotely explore its surroundings, as well as transmit the images it sees.

Dance enables HEXA to dance. You can let your creative ideas flow by utilizing a variety of motions.

Simulator Kit enables HEXA to synchronize with HEXA Simulator. You can design new Motions for HEXA.

Use Skills in Launcher

In Launcher, You can find all of HEXA's Skills, both pre-installed and the ones available for downloaded from the Skill Store.

Play around with pre-installed Skills

Explore

With Explore, HEXA becomes an extension of your eyes—enabling it to see, experience, and witness things you didn't even know existed. Remotely control HEXA and guide it through various terrains and locations, while it transmits what it sees back to you.



Open Explore by pressing the icon in Launcher.

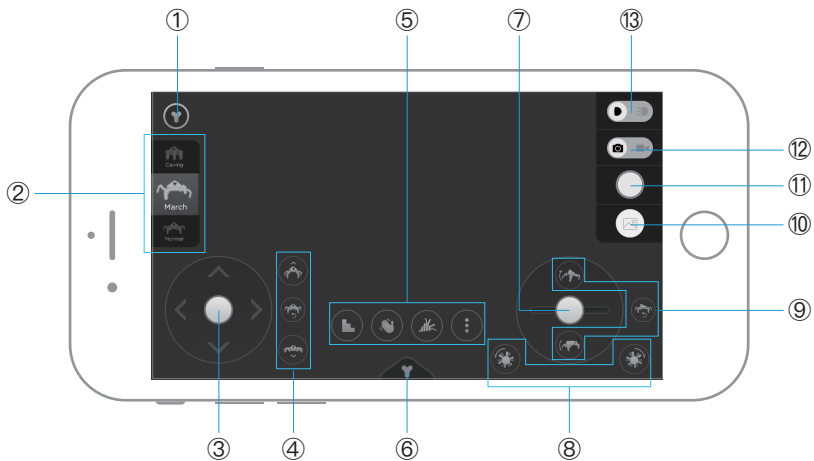

① Camera On/Off

② Control gait

③ Control movement direction

④ Control ground clearance

⑤ Conduct single behavior

⑥ Back to launcher

⑦ Head spinning

⑧ Control body yawing

⑨ Control body pitching

⑩ Album

⑪ Shutter

⑫ Take photos/Record videos

⑬ Night vision mode On/Off

 NOTE:

1. Explore is designed in landscape mode. We highly recommend you to play with both hands.
2. After opening the Explore, it could take 10 seconds before it is fully started.
3. To ensure video/photo quality, we recommend you to turn on night vision mode in low-light environments.
4. You can control HEXA by using the movement direction controller and head spinning controller. Also real time video will be transmitted.
5. Motion buttons enable you to explore different terrains and more possibilities.

Dance

Look out Beyoncé, HEXA is about to take the dance floor. And this dancer has the benefit of not two, but six legs.



Open Dance by pressing the icon in Launcher.

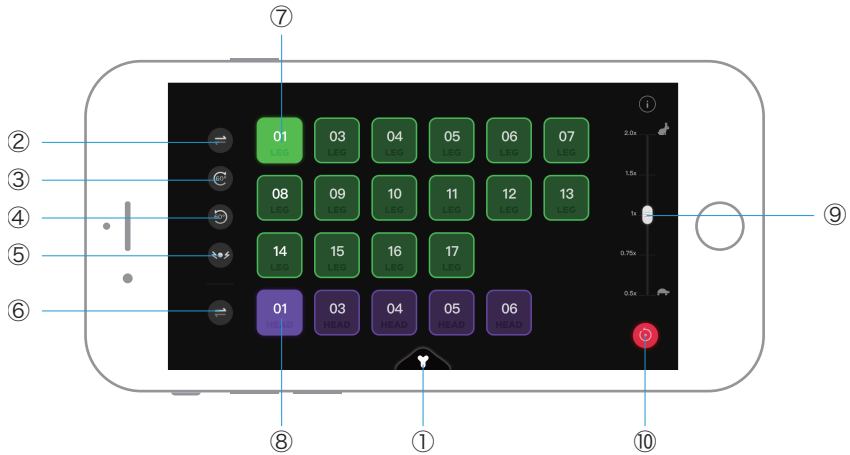

① Back to Launcher

② Reverse leg moves

③ Switch legs clockwise

④ Switch legs anti-clockwise

⑤ Mad mode (repeating the previous move)

⑥ Reverse head moves

⑦ Leg moves

⑧ Head moves

⑨ Speed controller

⑩ Reset

 NOTE:

1. Dance is designed in landscape mode. We highly recommend you play with both hands.
2. Adjusting the speed controller up or down will speed up or slow down the dance.
3. If you press  Mad button, HEXA will repeat the previous move quickly, entering a madly dancing mode. Press this button again, and HEXA will return to normal.

Simulator Kit

Can you design new motions for HEXA without any coding experience? The answer is YES! With Simulator Kit, you can synchronise a motion sequence in real HEXA.

1. Using your computer, download HEXA Simulator from Vincross official site at <https://www.vincross.com/en/download-hexa-simulator>
Both Mac and PC version are available.
2. HEXA and your Mac/PC computer must be connected to the same Wi-Fi network, or your Mac/PC already must be connected HEXA's Wi-Fi hotspot in Direct Link mode.
3. Open Simulator Kit by clicking the icon in Launcher. From the Simulator, you can easily design motions for HEXA as well as create a 3D testing environment for the robot.



Simulator Kit

 NOTE:

1. HEXA Simulator can ONLY be installed on a Mac/PC computer.
2. When directly connect your Mac/PC to HEXA, HEXA's default IP address is 192.168.251.1. When HEXA and your Mac/PC computer are connected to the same Wi-Fi network, HEXA IP address can be found in Simulator Kit.
3. Input HEXA IP address in HEXA Simulator, wait until the state becomes "connected".
4. Slight difference between the motions in Simulator and HEXA's performance may happen due to the environment.

If the problem persists, please contact support@vincross.com.

-  1. Since HEXA's servos are precise components, high-intensity movements may cause irreversible destructive effects on HEXA. We highly recommend that users do not attempt to have HEXA to jump or move at extreme speed, and so on. Damages caused by human factors will not be within the warranty.
2. Please make sure firewall, router and other settings will not block connections between your Mac/PC and HEXA.

Download more Skills

HEXA is an open platform. We welcome you to share your inspirations and publish your own Skills.

You can also enter the Skill Store from within the HEXA App to browse and download additional Skills, giving HEXA more capabilities and possibilities.

Transferring HEXA ownership

You are able to transfer the ownership of your HEXA to another user.

How to transfer HEXA ownership

1. Open the HEXA App, enter “Settings”-“Transfer HEXA ownership.”
2. Press the Transfer button and enter the password of the owner’s Vincross account.



You are not able to undo this action once the ownership transfer is complete.



After transferring HEXA ownership, the previous owner will become a trusted user of that HEXA. The current owner can remove the predecessor from the trusted users’ list, in order to be the sole trustee user and have sole access.

Part 2

Open Platform & Developer Tools

HEXA is an open platform for robot developers

HEXA is not only a ready-to-use all-terrain robot, but also a platform designed for robot developers. We encourage developers to create their own Skills, mobile applications, and internet applications for HEXA.

To make the development experience smooth and easy, we have prepared a well-documented SDK and tutorials. All developers are welcome to publish their own Skills to the community via Developer Bridge. They can also benefit from technical discussions with the HEXA community via our Developer Community online platform.

MIND SDK

HEXA's operating system is called MIND. With MIND SDK, developers will be able to develop Skills for HEXA and empower it to do almost anything you can imagine. Visit Vincross Developer Center

<https://developer.vincross.com/developer/introduction/mind-overview>

for more information about MIND SDK, its documentation, and tutorials.

Developer Bridge

With Developer Bridge, developers are able to distribute their Skills via the Skill Store. Visit <https://developer.vincross.com/developer/bridge> and become a Vincross developer now.

Developer Forum

In the Vincross Forum Development Discussion section, you can find peers to discuss, to inspire, and to create with. Visit





<https://forum.vincross.com/developer>
and join the community.

Part 3

HEXA's Features and Parameters

Power light







The signal light of the power on HEXA's posterior sideshows the current status of HEXA. You can quickly determine the current status by referring to the following table.

Light colors	Charging status	HEXA power
 Green light	Not charging	Power on
 Orange light	Charging	Power on
 Red light	Charging	Power off
 Light off	Fully charged/Not charging	Power off

 It is not recommended to operate HEXA while charging. Charging efficiency will be reduced significantly.

Head light

The light on HEXA's head shows the current status of your robot. You can quickly determine the current status by referring to the following table.

Light Status	Blinking	Steady
 Light purple	-----	Starting up
 Yellow	Waiting to scan QR code	-----
 Blue	Attempting to connect to Wi-Fi	In Wi-Fi mode
 Purple	Attempting to switch to Direct Link mode	In Direct Link mode
 Red	-----	Low power
 Green	-----	Resetting

Visual system

HEXA's vision system consists of a camera and an infrared transmitter, which are located at the head of your HEXA. You can use HEXA to explore different environments by watching the video its camera transmits to your mobile device. The infrared transmitter can provide night vision in low-light environments.

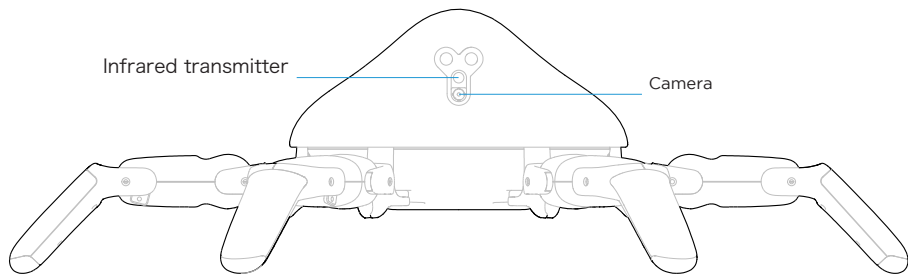

Explore, take pictures and videos

The built-in “Explore” Skill will allow you to explore HEXA’s surroundings, as well as to take pictures and videos.

Infrared night vision

In low-light environment, you can turn on the infrared transmitter  (night vision mode) to fill light for the camera.

Visual system parameters

Highest resolution: 1280 × 720

Electronic shutter: Auto

White balance: Auto

Field of view: 70°

Range of lens motion: unbounded 360° endless spin

Lens: f/2.8

Distortion: <1%

Power and charge

HEXA has a two-cell lithium-ion battery (6900mAh) that can be recharged via an AC/DC adapter or the wireless charging dock.

Battery display

When the power is low, HEXA's head light will remain red for a long time, while the HEXA App's Launcher will give you a heads-up. In lowest power situations, the HEXA App will pop up to tell you it will be shutting down soon.

Charging



You can charge HEXA using the AC/DC adapter or the wireless charging dock that connects to the AC/DC adapter.

Cable charging time: 2.5 hours

Wireless charging time: 4.5 hours

While charging with the wireless charging dock, the white light on the bottom will light up.

All battery claims depend on usage, environment and many other factors. Actual results may vary.

-  Please use the original AC/DC adapter. Charging HEXA with a third-party AC/DC adapter may cause serious damage to the HEXA and may result in fire.
-  It is not recommended to operate HEXA while charging. Otherwise, charging efficiency will be reduced significantly.

Legs

HEXA has six legs which are distributed in a symmetrical manner. Each leg has three joints and a non-slip pad on the toe.

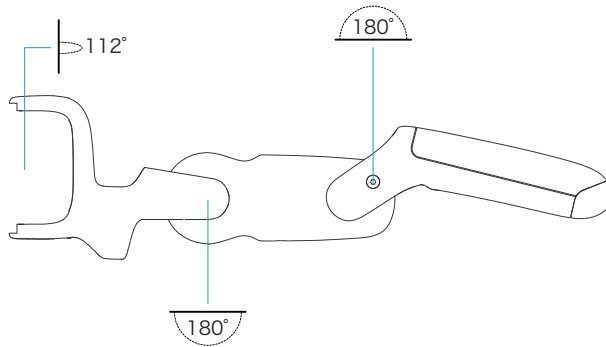

- ⊖ The leg joints are driven by high-performance motors. Do not rotate them by hand. This may cause serious damage regardless of whether HEXA is powered on or off.

Specs

Size

Diameter: 20 inches (508mm)

Height: 4.7 inches (120mm)

Weight

Net weight (including battery): 1550g

Operating environment

Operating ambient temperature:

50°-95°F (10°-35°C)

Operating altitude: tested up to

6562 feet (2000m)

Battery

Battery type: Lithium-ion battery

Capacity: 6900mAh

Battery life: 45-180min

Depending on the actual use of the case

Charging

Charging method: Use the AC/DC adapter to charge directly. Or use the wireless charging dock to charge.

AC/DC adapter input voltage: 100-240V

Rated frequency: 50/60Hz

AC/DC adapter output voltage: 9V

Wired charging time: 2.5 hours

Wireless charging time: 4.5 hours

All battery claims depend on signal strength, feature configuration, usage, and other factors. Actual results may vary.

 Please use original AC/DC adapter to charge. Using third party AC/DC adapter to charge may severely damage HEXA and cause fire.

 It is not recommended to operate HEXA while charging, otherwise the charging efficiency will be significantly reduced.

Visual system

Sensor: 2.5" CMOS
Effective pixels: 5 million
Field of view: 70°
Range of lens motion:
unbounded 360° endless spin
Aperture: f/2.8
Distortion: <1%
Maximum resolution: 1280 × 720
Shooting mode:
taking photos / recording videos
Recording resolution: 720p
Infrared night vision: Yes

Wireless communication

Support Wi-Fi
Wireless Standards: IEEE 802.11b/g/n

Distance measuring sensor

Sensor: infrared emitting diode
Range: 4-59 inches (10cm-150cm)

Hardware interfaces

USB 2.0
3.5mm audio line in
3.5mm audio line out
GPIO x 4
I²C x 1
ADC x 4
5V power output
3.3V power output

Part 4

Services and System Updates

Services and support

We will always pay close attention to any problems you may encounter while using HEXA. Please check the after-sale service policies and repair service policies at the Vincross official website:

<https://www.vincross.com/support/service-policies>

You can also get service and support in the following ways:

- 1.** You can click “Customer service” on the order detail page to enter the after-sales system. In addition, the after-sales system can be found at the Services and Support page on the Vincross website (**<https://www.vincross.com/support>**).
- 2.** You can directly email to **support@vincross.com**. Our staff will contact you as soon as possible.
- 3.** you can post development questions to the Vincross Forum’s Development Discussion section (**<https://forum.vincross.com/developer>**) in order to discuss issues with other community developers.

System update

HEXA's operating system MIND and HEXA App will update regularly. When you open the HEXA App and receive an update prompt, please update while connected to a Wi-Fi network. Using lower versions of MIND or HEXA App may affect your HEXA experience.

MIND SDK will also be constantly updated. Please stay tuned for the Developer Center and Developer Forum.

Update “HEXA User Guide”

Vincross will update the HEXA User Guide from time to time to help you keep up with HEXA newest instructions. Please download the latest version from the Vincross website at:

<https://www.vincross.com/support/hexa-user-guide>



FCC STATEMENT

THIS DEVICE COMPLIES WITH PART 15 OF THE FCC RULES. OPERATION IS SUBJECT TO THE FOLLOWING TWO CONDITIONS: (1) THIS DEVICE MAY NOT CAUSE HARMFUL INTERFERENCE, AND (2) THIS DEVICE MUST ACCEPT ANY INTERFERENCE RECEIVED, INCLUDING INTERFERENCE THAT MAY CAUSE UNDESIRE OPERATION.

NOTE: This equipment has been tested and found to comply with the limits for a Class B digital device, pursuant to part 15 of the FCC Rules. These limits are designed to provide reasonable protection against harmful interference in a residential installation. This equipment generates, uses and can radiate radio frequency energy and, if not installed and used in accordance with the instructions, may cause harmful interference to radio communications. However, there is no guarantee that interference will not occur in a particular installation. If this equipment does cause harmful interference to radio or television reception, which can be determined by turning the equipment off and on, the user is encouraged to try to correct the interference by one or more of the following measures: - Reorient or relocate the receiving antenna. - Increase the separation between the equipment and receiver. -Connect the equipment into an outlet on a circuit different from that to which the receiver is connected. -Consult the dealer or an experienced radio/TV technician for help.

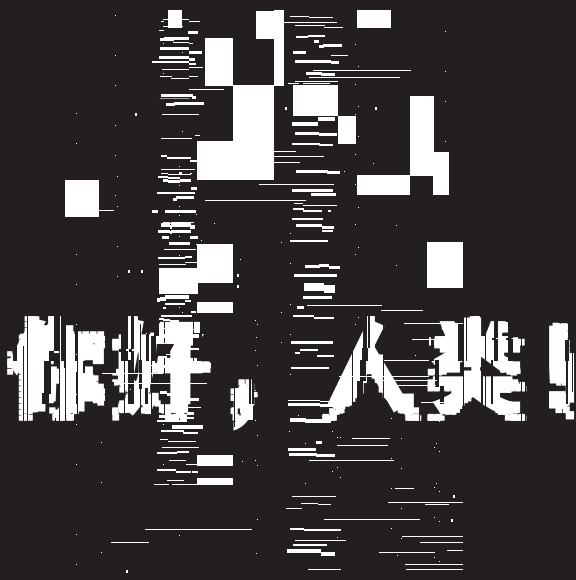

HE*H 用户指南



www.vincross.com

© 2017 Vincross 版权所有

你好，

我是天齐，HEXA的创造者。很高兴你读到这段话。根据我们的猜测，大约73%的人类导师会跳过说明书，直接开始折腾HEXA，然后在某个问题上，再返回这本指南。还有20%的人类导师，完全不会阅读这本指南，他们会通过朋友、社群以及互联网，开始自己的人类导师之旅。

通常这种致辞，会情绪激昂地说一些鼓舞人心、畅想未来的陈词滥调。可是你已经拥有HEXA了，我没必要再在这里做广告。我知道，如果你对明天没什么想法，肯定也不会在这儿一手端着HEXA，一手读着这本指南。

总而言之，非常高兴你和我，咱们成为HEXA的第一批人类导师，一起走进机器人开发的世界。

“有一天，我打开了一个盒子，那一刻，我成了HEXA的第一批人类导师……”希望30年后，奇点到来之日，我们会用这句话做开场白。

祝你和HEXA玩得开心。我要回去写代码了。

孙天齐

A handwritten signature in black ink, appearing to be '天齐' (Tianqi) in a stylized, cursive script.

目录

第一部分 初次使用HEXA

认识HEXA	02
HEXA简介	02
HEXA示意图	03
HEXA底部示意图	04
硬件接口	05
激活HEXA	06
初次下载HEXA App并激活	06
激活更多HEXA	12
未成功激活的解决方法	15
HEXA与App之间的连接	16
使用Wi-Fi模式连接HEXA	16
Wi-Fi连接不成功的解决方法	20
使用直连模式连接HEXA	24
直连不成功的解决方法	27
恢复出厂设置	28
如何恢复出厂设置	28
Skill	30
HEXA预装的Skill	30
在HEXA Launcher中运行Skill	31
立刻体验预装的Skill	31
下载更多Skill	39
如果你要把HEXA送给朋友	40
转让主人身份的步骤	40

第二部分 成为HEXA开发者

HEXA是一个机器人开发平台	42
MIND SDK	42
Developer Bridge	42
开发者论坛	43

第三部分 HEXA的特性与参数

电源指示灯	45
头顶指示灯	46
视觉系统	47
探索、拍照与摄像	48
电量与充电	49
低电量提示	49
充电	50
腿部	51
技术参数	52

第四部分 服务与更新

服务与支持	57
系统更新	58
更新《HEXA用户指南》	59

第一部分
初次使用HEXA

认识HEXA

HEXA简介

HEXA是Vincross研发的全地形机器人。它不但能够行走、攀爬和钻洞，而且内置摄像头、红外发射器和测距传感器。使用基于Linux内核的MIND操作系统，让开发者可以轻松编程。HEXA还带有丰富的硬件接口，如USB、标准音频输入和输出、I²C、ADC、GPIO，以及5V和3.3V电源输出。

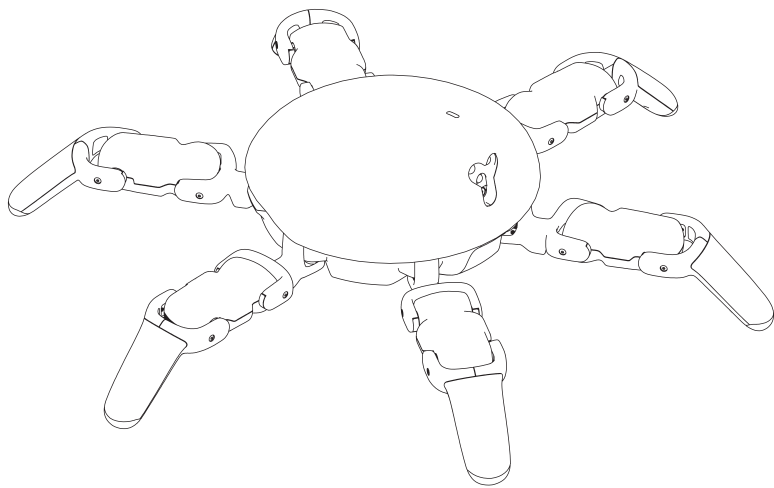

HEXA示意图

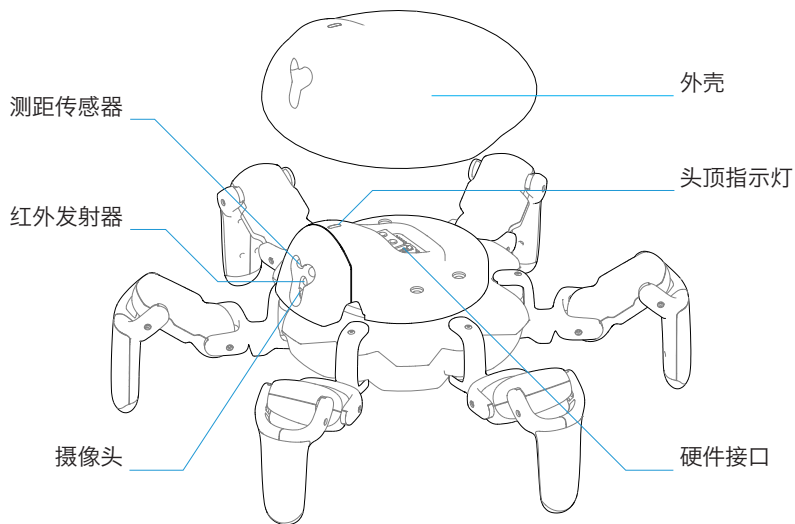

HEXA (1个)

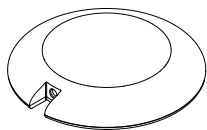

无线充电基座 (1个)

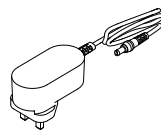

电源适配器 (1个)

HEXA底部示意图

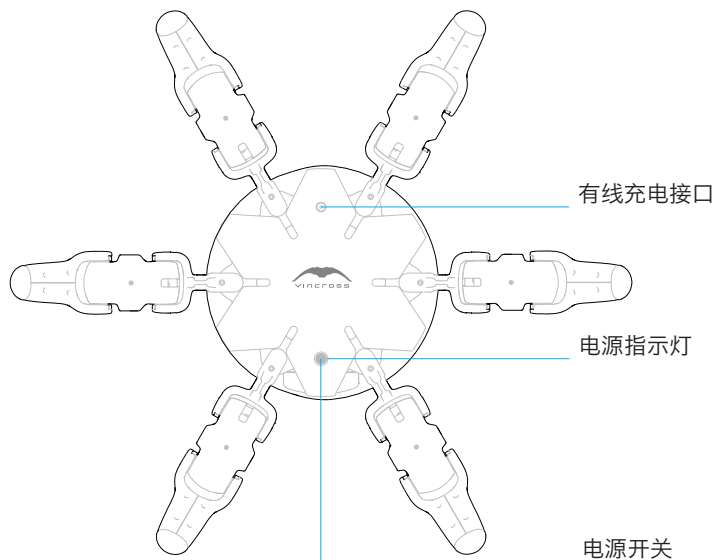

硬件接口

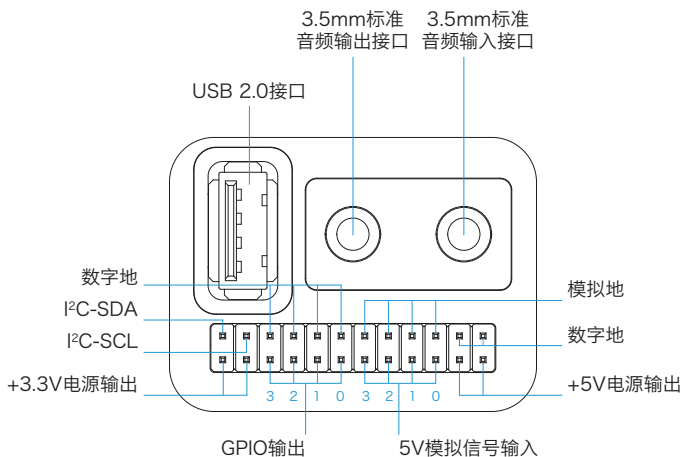

HEXA的硬件接口位于外壳的下方。用力向上拉外壳，即可将其打开。

- ❌ 请使用配套提供的电源适配器进行充电，使用非配套电源适配器进行充电可能会严重损坏HEXA，并有可能造成火灾。

激活HEXA

初次下载HEXA App并激活

购买HEXA并初次下载HEXA App的用户，在首次打开app并注册登录后，会自动进入激活界面。激活需要移动设备和HEXA同时处于Wi-Fi环境下。

激活HEXA流程说明

1. 下载HEXA App。激活与控制HEXA都需要通过HEXA App。下载完成后，App将引导您注册账号和进行初始设置。设置必须在Wi-Fi状态下进行，以便您的HEXA和移动设备通过互联网连接。

iPhone用户请在App Store搜索“**Vincross HEXA**”并下载；

安卓用户可前往Google Play搜索“**Vincross HEXA**”并下载，

或前往Vincross官网下载APK安装包：

<https://www.vincross.com/download-hexa-app>

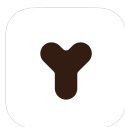



2. 手机连上Wi-Fi时运行HEXA App。点击按钮“让我们开始吧!”

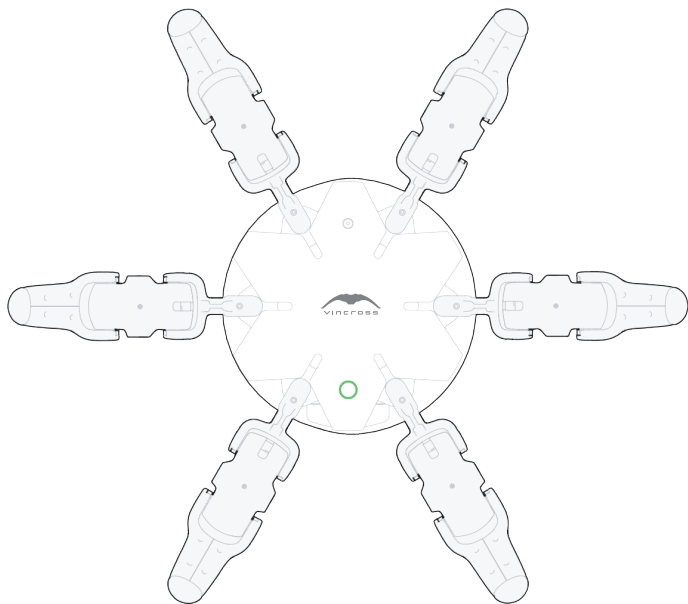

3. 按照App中的提示，按下HEXA底部的电源开关，电源指示灯亮起，代表HEXA已开机。

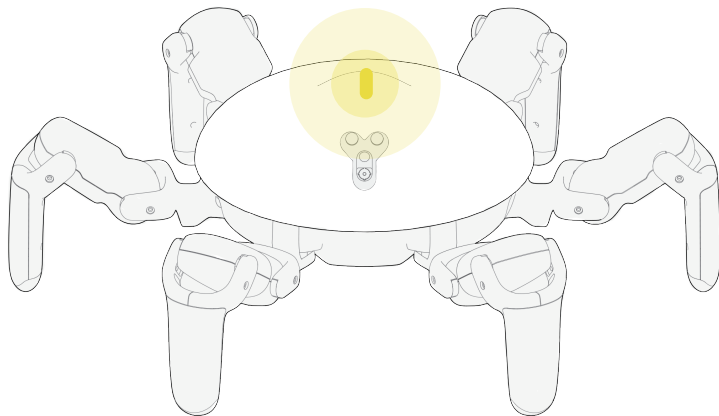

4. 等待直到HEXA头顶指示灯变为黄色闪烁灯光。



5. 在HEXA App中点击“下一步”，然后为HEXA选择一个可用的Wi-Fi，并输入Wi-Fi密码。

⚠️ HEXA无法接入以下类型的Wi-Fi网络：5GHz，企业级路由器（enterprise secured），ad-hoc（或peer-to-peer），以及需要Web浏览器进行身份验证的公共网络。

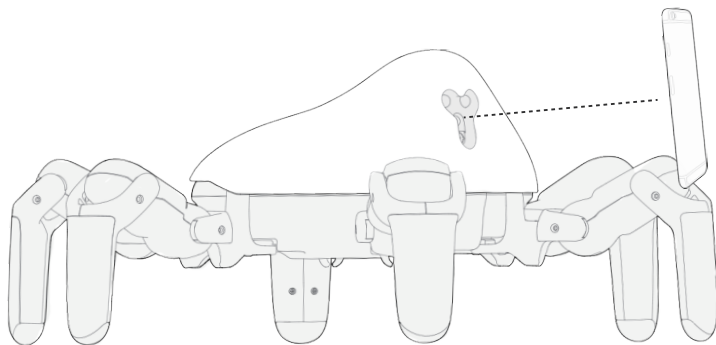

6. 将生成的二维码放在HEXA正前方，对准摄像头并等待识别，约30-60秒，直到HEXA头顶指示灯变为稳定的蓝色灯光。继续等待30-60秒，HEXA App会自动跳转至HEXA Launcher（可直接跳至第31页，了解如何在Launcher中运行Skill）。

激活更多HEXA

一个用户可以拥有多个HEXA，那将无比有趣！您可以按照以下说明，激活第二个或更多的HEXA。

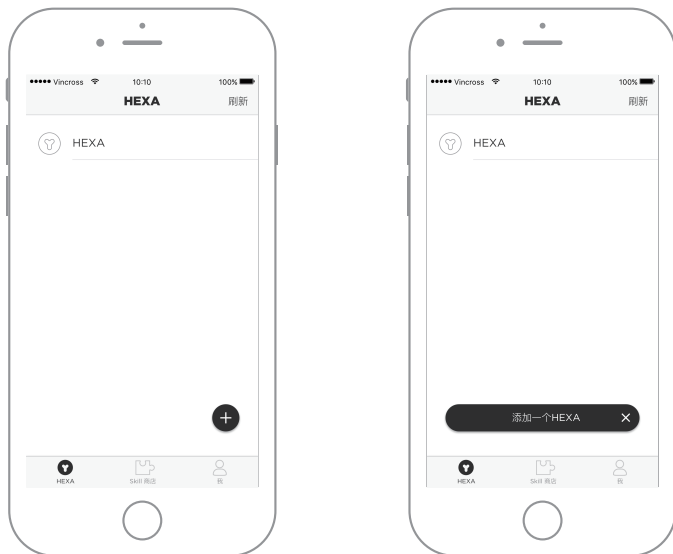

1. 打开HEXA App并登录，点击“+”按钮，按钮展开后点击“添加一个HEXA”。



2. 在新的页面中点击下方的“**激活一个新的HEXA**”。



3. 进入激活流程，请按照第6页“初次下载HEXA App并激活”的步骤操作。

未成功激活的解决方法

如果您在激活HEXA时遇到问题，请考虑以下解决方法。

可能的原因	解决方法
HEXA没有成功扫描二维码	将手机屏幕中的二维码以垂直角度对准摄像头扫描，可尝试调整前后距离以便扫码成功。
Wi-Fi没有连接到互联网	切换到可以连接到互联网的Wi-Fi。
Wi-Fi密码不正确	返回到激活流程第二步，输入正确的Wi-Fi密码。
网络连接超时	换到Wi-Fi信号稳定的环境重新开始激活流程。
HEXA已经被激活过	HEXA的头顶指示灯从黄色闪烁灯光状态大约1分钟后变为紫色稳定灯光。若您不是HEXA的信任用户，请联系HEXA主人以获得信任用户权限。

如果问题仍然存在，请联系support@vincross.com，我们会竭力为您解决。

 HEXA无法接入以下类型的Wi-Fi网络：

- 5GHz;
- enterprise secured;
- ad-hoc (或peer-to-peer);
- 需要Web浏览器进行身份验证的公共网络。

HEXA与App之间的连接

HEXA与HEXA App之间，有两种连接的模式：

1. Wi-Fi模式（ 或 ）

2. 直连模式（）

使用Wi-Fi模式连接HEXA

当手机与HEXA通过Wi-Fi模式连接时，HEXA会自动判断当前网络为局域网或互联网。

当HEXA与手机连接到同一个Wi-Fi网络时，HEXA将显示为  局域网连接。

当HEXA与手机不在同一个Wi-Fi网络时，HEXA将显示为  互联网连接。

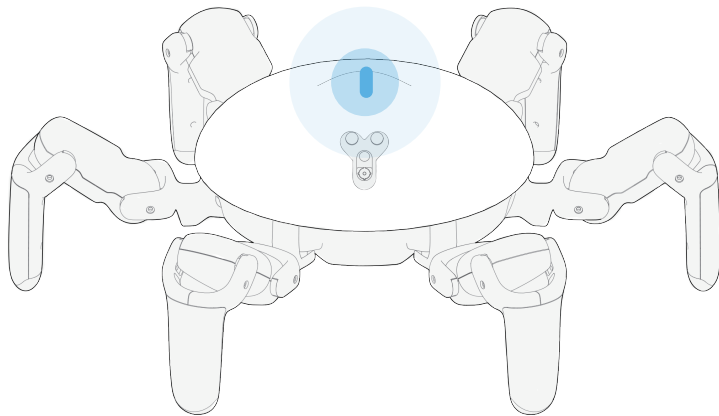

1. 打开HEXA的电源开关，HEXA头顶指示灯闪烁蓝色灯光，显示它正在尝试连接Wi-Fi网络。



2. 将手机连接到带有互联网连接的Wi-Fi网络，然后打开HEXA App。

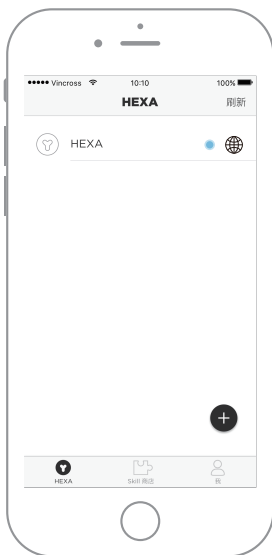

3. 找到HEXA，后缀为 🌐 或 📶 图标。点击HEXA图标，跳转至 HEXA Launcher。

Wi-Fi连接不成功的解决方法

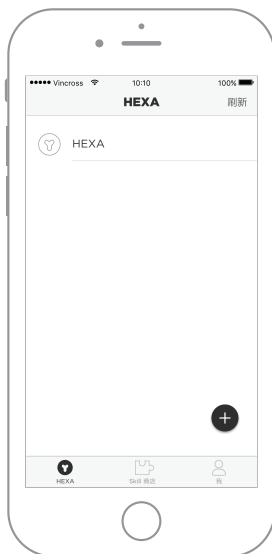

1. 找到HEXA，如果列表中HEXA名称右侧没有任何图标，表示HEXA App尚未扫描到此HEXA。



2. 此时可点击HEXA名称对应的条目，进入提示页面，根据HEXA头顶指示灯的颜色点击对应按钮。

情况1： HEXA头顶指示灯为黄灯。

表示HEXA正在等待扫描二维码连接网络，可根据提示为HEXA选择一个可用的Wi-Fi，让HEXA连接至此Wi-Fi。



说明：此时HEXA的直连模式也处于开启状态，可参考第24页使用直连模式连接HEXA的步骤操作连接上HEXA。

情况2： HEXA头顶指示灯为紫灯。

表示HEXA在黄灯状态下等待超过时间限制，摄像头已关闭且自动切换到直连模式。请重启HEXA，按照流程为HEXA接入Wi-Fi，或参考第24页使用直连模式连接HEXA的步骤操作。



HEXA无法接入以下类型的Wi-Fi网络：

- 5GHz;
- enterprise secured;
- ad-hoc (或peer-to-peer);
- 需要Web浏览器进行身份验证的公共网络。

如果您在Wi-Fi状态下与HEXA连接时遇到困难，请确认：

1. 请确认为HEXA输入的Wi-Fi密码正确。
2. 请检查HEXA所在的Wi-Fi信号是否较强且稳定。
3. 请确认您是这个HEXA的主人或信任用户。

如果问题仍然存在，请联系support@vincross.com，我们会竭力为您解决。

使用直连模式连接HEXA

直连模式适合HEXA在户外或者没有可用Wi-Fi网络的环境。在直连模式下，HEXA成为热点，手机连接到该热点后，即可通过HEXA App连接HEXA。

使用直连模式连接HEXA流程说明

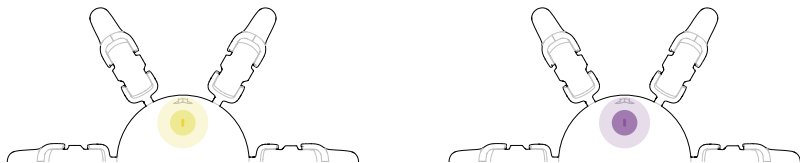

1. 在无可用网络的环境下打开HEXA的电源开关，HEXA头顶指示灯在短暂的浅紫色后，会变为闪烁黄色灯光，并最终呈现稳定的紫色灯光。在黄灯或紫灯的状态下，都可以通过直连模式与HEXA建立连接。



说明：当您与HEXA通过Wi-Fi模式连接时，您可以通过HEXA App中的“设置”将连接模式切换到直连模式。



2. 打开手机的网络设置, 在可选取的网络中, 找到名为“HEXA-xxxxxxxxxxxx”的网络, 点击连接并输入密码, 密码为Wi-Fi名称的后8位。

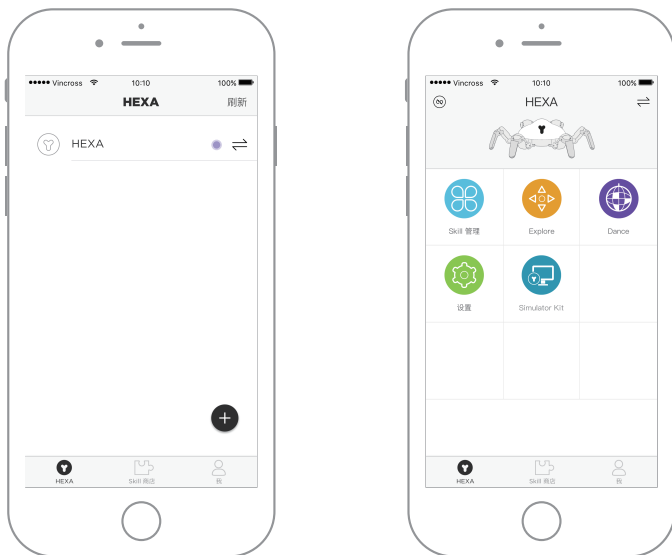

3. 打开HEXA App，图标  显示HEXA处于直连模式。点击该HEXA名字并连接，即可进入HEXA Launcher。

注：在HEXA已接入Wi-Fi时，也可通过HEXA App的“设置”，使它进入直连模式。

直连不成功的解决方法

1. HEXA必须已激活。未激活的HEXA无法自动进入直连模式。
2. 若HEXA头顶指示灯变为蓝色，则表示它已经自动连接到某个Wi-Fi网络，此时HEXA无法自动进入直连模式，需要在HEXA App的“设置”中手动切换到直连模式。
3. 请检查手机网络设置，确认已经接入HEXA的热点。
4. 请确保您是这个HEXA的主人或信任用户。
5. 在室温环境下，请确保您与HEXA的距离在50米（160英尺）以内，过远的距离会导致无法进入直连模式。

如果问题仍然存在，请联系support@vincross.com，我们会竭力为您解决。

恢复出厂设置

! 为HEXA恢复出厂设置将清除掉本台HEXA上的所有数据和设置。完成后不能恢复原有设置。

如何恢复出厂设置

1. 当HEXA电源关闭并未在充电状态时，将杜邦线按照下图进行连接，开机后HEXA将自动完成恢复出厂设置过程。

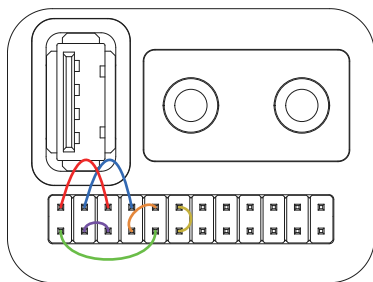

! 在进行恢复出厂设置操作之前，请确保HEXA处于关机状态，且不要接入电源，以免造成主板损坏。

2. 打开HEXA的电源开关，HEXA开始启动，头顶指示灯将出现稳定浅紫色灯光，持续约5-10秒。
3. 指示灯变为稳定绿色灯光，代表HEXA开始恢复出厂设置，持续约20秒。
4. 指示灯变为黄色闪烁灯光，代表HEXA已完成恢复出厂设置。此时请关闭HEXA电源开关。
5. 拔掉所有插线，重新开机，按照第6页“初次下载HEXA App并激活”操作重新激活HEXA。

Skill

Skill是HEXA的应用，相当于电脑上的软件，或者手机上的app。

HEXA预装的Skill

我们为每一台HEXA预装了3个有趣的Skill: Explore、Dance和Simulator Kit。您可以在HEXA Launcher中找到它们。

Explore使HEXA可以遥控探索周围，并实时传回它所看到的画面。

Dance使HEXA可以跳舞，您可以发挥创意，玩出各种动作组合。

Simulator Kit可以让您通过HEXA Simulator同步HEXA，并轻松为HEXA设计新动作。

在HEXA Launcher中运行Skill

无论是您在Skill Store中下载的Skill，还是HEXA预装的Skill，都能在HEXA Launcher中找到。点击您想使用的Skill的图标，即可运行该Skill。

立刻体验预装的Skill

运行Explore

使用Explore，HEXA可以变成您的另一双眼睛，让您以不同的视角观察、探索，仿佛亲身体验各种环境，甚至进入人类难以进入的空间。

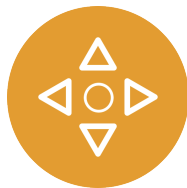

点击Explore图标，进入运行页面

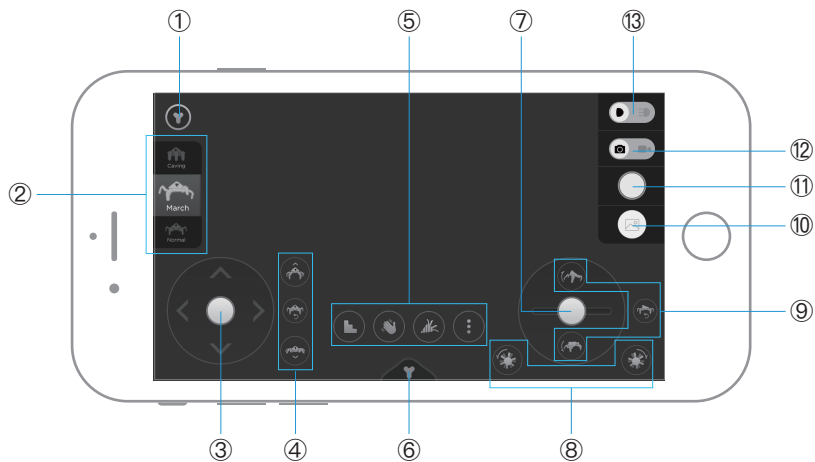

① 开启/关闭摄像头

② 调整步态

③ 控制移动方向

④ 调整身体离地高度

⑤ 执行单次动作

⑥ 返回主界面

⑦ 控制头部旋转

⑧ 控制身体旋转

⑨ 调整俯仰角度

⑩ 相册

⑪ 快门

⑫ 拍照/录像切换

⑬ 开启/关闭夜视模式

 说明

1. Explore采用横屏操控模式，双手触控乐趣更多。
2. 进入Explore，约有10秒的启动时间。
3. 在弱光线环境下，建议开启夜视模式为视频补光。
4. 通过拖动行走摇杆和转头摇杆，HEXA将在您的操控下自如灵活地探索周边，并将实时画面回传到您的手机。
5. 动作按钮为您操控HEXA带来更多可能，爬高走低，不在话下。

运行Dance

使用Dance，您可以亲自为HEXA编舞，让它成为六条腿的舞蹈大师。从太极到Locking，HEXA无所不能。



点击Dance图标，进入运行页面。

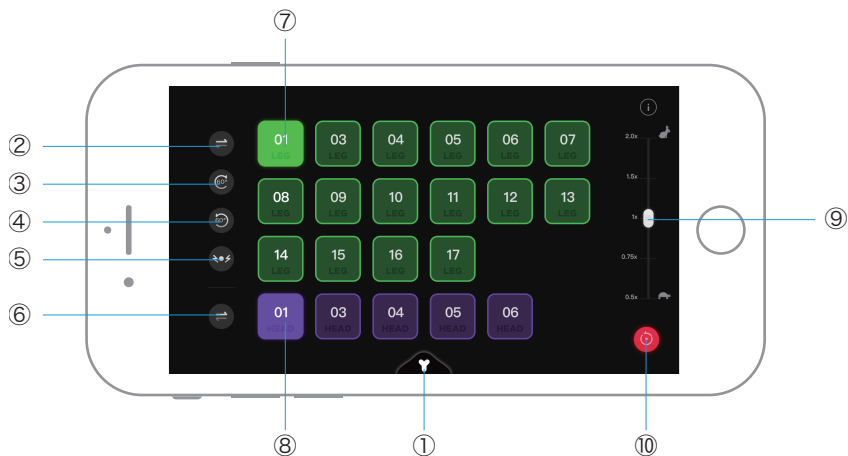

① 返回Launcher

② 腿部动作倒做

③ 顺时针换下一组腿做动作

④ 逆时针换下一组腿做动作

⑤ Mad键（快速重复刚刚的动作）

⑥ 头部动作倒做

⑦ 腿部动作

⑧ 头部动作

⑨ 速度控制滑杆

⑩ 复位

 说明

1. Dance采取横屏操控模式，双手触控乐趣更多。
2. 拖动速度控制模块，HEXA动作会加快或减慢。
3. 点击Mad键  ，HEXA会快速重复刚刚的动作，进入疯狂热舞状态。
再次点击Mad键，HEXA解除Mad魔咒。

运行Simulator Kit

您是导演，HEXA是演员。即使没有编程基础，您依然可以通过Simulator Kit，把在Simulator中创作的奇思妙想同步到真实的HEXA上。

1. 从Vincross官网下载HEXA Simulator到您的电脑，地址为
<https://www.vincross.com/cn/download-hexa-simulator>
HEXA Simulator支持Mac系统和Windows系统。
2. 您的Mac/PC与HEXA需要在同一个局域网中，或已连接到处于直连模式的HEXA的Wi-Fi热点。
3. 在HEXA Launcher中点击Simulator Kit图标，进入说明页面。按照步骤您将开启奇妙的动作设计之旅。



Simulator Kit

 说明

1. HEXA Simulator只能安装在MAC/PC电脑上。
2. 直连模式下HEXA默认IP是192.168.251.1，同处局域网下的IP地址可以在Simulator Kit中里找到。
3. 在HEXA Simulator中输入HEXA IP地址，点击Connect，等待状态变为Connected即连接成功。
4. 由于客观环境条件的限制和影响，HEXA Simulator中设计的动作会与HEXA实际做出的动作有微小差异。

如果问题仍然存在，请联系support@vincross.com，我们会竭力为您解决。

-  1. 由于HEXA的舵机是精密部件，高强度动作极易损坏舵机，并对HEXA的其他部分造成不可逆的影响。我们强烈建议用户不要试图让HEXA完成跳跃、用极限速度移动等动作。人为因素导致的舵机损害将不在保修范围内。
2. 请确保防火墙、路由器及其他设置不会拦截您的MAC/PC连接HEXA。

下载更多Skill

HEXA是一个开放的平台，欢迎您分享灵感，在HEXA平台发布原创的Skill。

您也可以进入HEXA App中的Skill Store，去浏览并下载更多的Skill，为HEXA带来更多新功能与玩法。

如果你要把HEXA送给朋友

用户可以转让HEXA的主人身份。

转让主人身份的步骤

1. 打开HEXA App，进入设置—用户—转让HEXA；
2. 点击“转让HEXA”按钮，输入原主人账号密码，确认后即可转让成功。

 转让主人身份的过程不可逆，当您将HEXA主人的身份转让给其他用户后，您将不能单方面恢复成该HEXA的主人。

 在完成转让主人身份后，原主人变为这一个HEXA的信任用户。新主人可以从信任用户名单中删除原主人。

第二部分

成为HEXA开发者

HEXA是一个机器人开发平台

HEXA不仅是开机即用的全地形机器人，也是为机器人开发者而设计的开发平台。开发者可以按照自己的想法为HEXA开发Skill、移动app以及互联网应用。我们为开发者准备了详尽的SDK、文档与教程，帮助您走进HEXA开发的世界。另外，您可以通过Developer Bridge，向社区发布您开发的Skill。您还可以在开发者社区中发起或参与讨论。

MIND SDK

HEXA使用MIND系统，通过MIND SDK，开发者可以开发HEXA Skill，赋予HEXA更多能力。请在Vincross开发者中心查看MIND SDK的文档和教程。

<https://developer.vincross.com/developer/introduction/mind-overview>

Developer Bridge

通过Developer Bridge，您可以向社区发布您开发的Skill。

<https://developer.vincross.com/developer/bridge>

开发者论坛

在开发者论坛中，您可以找到同类，并与大家讨论您的问题、创想和杰作。





立即加入：<https://forum.vincross.com/developer>

第三部分

HEXA的特性与参数

电源指示灯

HEXA的电源键指示灯可以显示HEXA的工作状态，通过下表您可以快速确定HEXA当前的情况。

指示灯状态	充电状态	是否开机
 绿灯	未充电	开机
 橙灯	充电中	开机
 红灯	充电中	关机
 灯熄灭	充满电/未充电	关机

 为保证充电效率，建议在充电过程中让HEXA的电源处于关闭状态。

头顶指示灯

HEXA头顶指示灯可以显示HEXA当前的状态，通过下表您可以快速确定HEXA目前的状况。

指示灯状态	闪烁	稳定
 浅紫色灯光	-----	正在开机
 黄色灯光	等待扫描二维码	-----
 蓝色灯光	正在尝试连接到Wi-Fi	处于Wi-Fi模式
 紫色灯光	正在启用直连模式	处于直连模式
 红色灯光	-----	电量低
 绿色灯光	-----	正在恢复出厂设置

视觉系统

HEXA的视觉系统由摄像头和红外发射器组成，它们位于HEXA头部。通过回传到手机的实时画面，用户可以用HEXA来探索不同环境。红外发射器可以在弱光线环境下补光，使HEXA能够夜视。

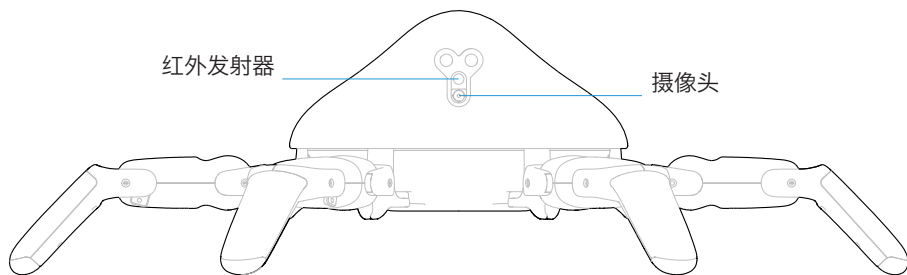

探索、拍照与摄像

使用HEXA App中内置的Explore Skill可以使用HEXA探索周围环境，并拍照与摄像。

红外夜视补光

在Explore Skill中，弱光线环境下，可以开启红外发射器的  夜视模式为摄像头补光。

视觉系统参数

最高分辨率：1280 × 720

电子快门：自动

白平衡：自动

视场：70°

镜头活动范围：无边界360°无限旋转

镜头：f/2.8

畸变：<1%

电量与充电

HEXA的电池为两节串连的锂离子电池（共6900mAh），可以通过电源适配器或无线充电基座充电。

低电量提示

当HEXA的电量较低时，头顶指示灯为红色灯光，同时HEXA App的Launcher将提示“电量不足”。在电量过低时，HEXA App将跳出弹窗提示“HEXA电量过低，即将自动关机”。

充电

可以使用电源适配器或连接电源适配器的无线充电基座为HEXA充电。

有线充电时间：2.5h

无线充电时间：4.5h

在使用无线充电时，无线充电基座会亮起白色灯光提示正在充电。

电池情况和充电时间因使用情况和环境而异。

 请使用配套提供的电源适配器进行充电，使用非配套电源适配器进行充电可能会严重损坏HEXA，并有可能造成火灾。

 为保证充电效率，建议在充电过程中让HEXA电源处于关闭状态。

腿部

HEXA有6条腿，以中心对称的方式分布。每条腿有三个关节，并在脚尖装有防滑垫。

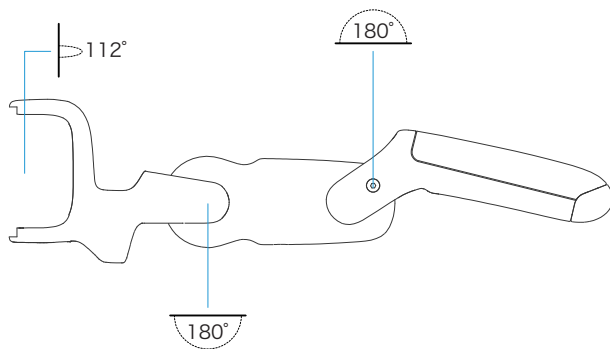

- ❌ 腿部关节由高性能电机驱动，无论在开机或关机状态下，都严禁用手转动，否则有可能造成严重损坏。

附录：技术参数

参数

尺寸

直径：508mm

高度：120mm

重量

净重：1550g

操作环境

工作温度：10°-35°C

最大操作高度：海拔2000米以下

电源

电池类型：2S锂离子电池

电池容量：6900mAh

续航时间：45-180min（续航时间视实际使用情况和环境而异）

充电

充电方式：使用电源适配器直接充电；或使用无线充电基座充电

电源适配器输入电压：100-240V交流

额定频率：50/60Hz

电源适配器额定输出电压：9V直流

有线充电时间：2.5h

无线充电时间：4.5h

电池情况和充电时间因使用情况和环境而异。

 请使用配套提供的电源适配器进行充电，使用非配套电源适配器进行充电可能会严重损坏HEXA，并有可能造成火灾。

 建议不要在充电的同时操作HEXA，否则将显著降低充电效率。

视觉系统

传感器：2.5英寸CMOS

有效像素：500万

视场：70°

镜头活动范围：无边界360°无限旋转

光圈：f/2.8

畸变：<1%

最大分辨率：1280 × 720

拍摄模式：拍摄/录像

录像分辨率：720p

红外夜视：支持

无线通信

支持Wi-Fi技术；

符合IEEE 802.11 b/g/n标准

测距传感器

传感器：红外线

测距范围：10-150cm (4-59inches)

扩展硬件接口

USB2.0接口

3.5mm标准音频输入接口

3.5mm标准音频输出接口

GPIO × 4

I²C × 1

ADC × 4

5V电源输出

3.3V电源输出

第四部分

服务与更新

服务与支持

我们将始终关心您在使用HEXA过程中遇到的问题。请在Vincross官网查看售后服务政策和维修服务政策：

<https://www.vincross.com/support/service-policies>

您也可以通过以下途径获得服务支持：

1. 您可以通过订单详情页面点击“售后服务”进入售后系统，也可以在Vincross官网中的服务与支持页面（<https://www.vincross.com/support>）中找到售后系统。
2. 您可直接发送邮件至support@vincross.com，我们的工作人员会尽快与您联络。
3. 关于开发的问题，您可以在Vincross Forum的开发者版（<https://forum.vincross.com/developer>）发帖，与社区的其他开发者展开讨论。

系统更新

HEXA的操作系统MIND以及HEXA App将会定期更新。当您打开HEXA App，收到更新提示时，请在Wi-Fi环境下更新。未及时更新有可能会影响您的HEXA使用体验。

MIND SDK也会不断更新，请关注开发者中心和开发者论坛。

更新 《HEXA用户指南》

Vincross会不定期在线上更新《HEXA用户指南》，帮助您更好地使用。请在Vincross官网查看最新的版本。

下载地址：<https://www.vincross.com/support/hexa-user-guide>

